



DESIGNNAV

The Scientific Pixel





DESIGNNAV
The Scientific Pixel

Welcome to DESIGNNAV

DESIGNNAV is a specialized design studio dedicated to the medical, pharmaceutical, and healthcare industries.

With a team of expert designers, animators and medical consultants, we turn complex scientific ideas into visually engaging, easy-to-understand content.





Our Vision

To be a globally trusted design and animation partner for healthcare professionals, pharma companies, and medical device manufacturers. We envision improving patient awareness and advancing medical understanding by making healthcare communication visual, accessible, and meaningful.

Our Mission

To transform complex medical, scientific, and healthcare concepts into clear, accurate, and engaging visual experiences. Through high-quality design and animations, we aim to support patient education, medical training, and healthcare communication with clarity, precision, and impact.



Medical Animation

We simplify anatomy, clinical procedures, and treatment processes through clear and scientifically accurate animations for patient awareness, academic use, and professional training. Our pharma-focused animations also include detailed mechanism of action (MoA) visualizations and drug interaction sequences that explain how therapies work at a molecular and systemic level.

By combining medical precision with compelling storytelling, we help pharmaceutical brands communicate complex science with clarity, confidence, and impact.

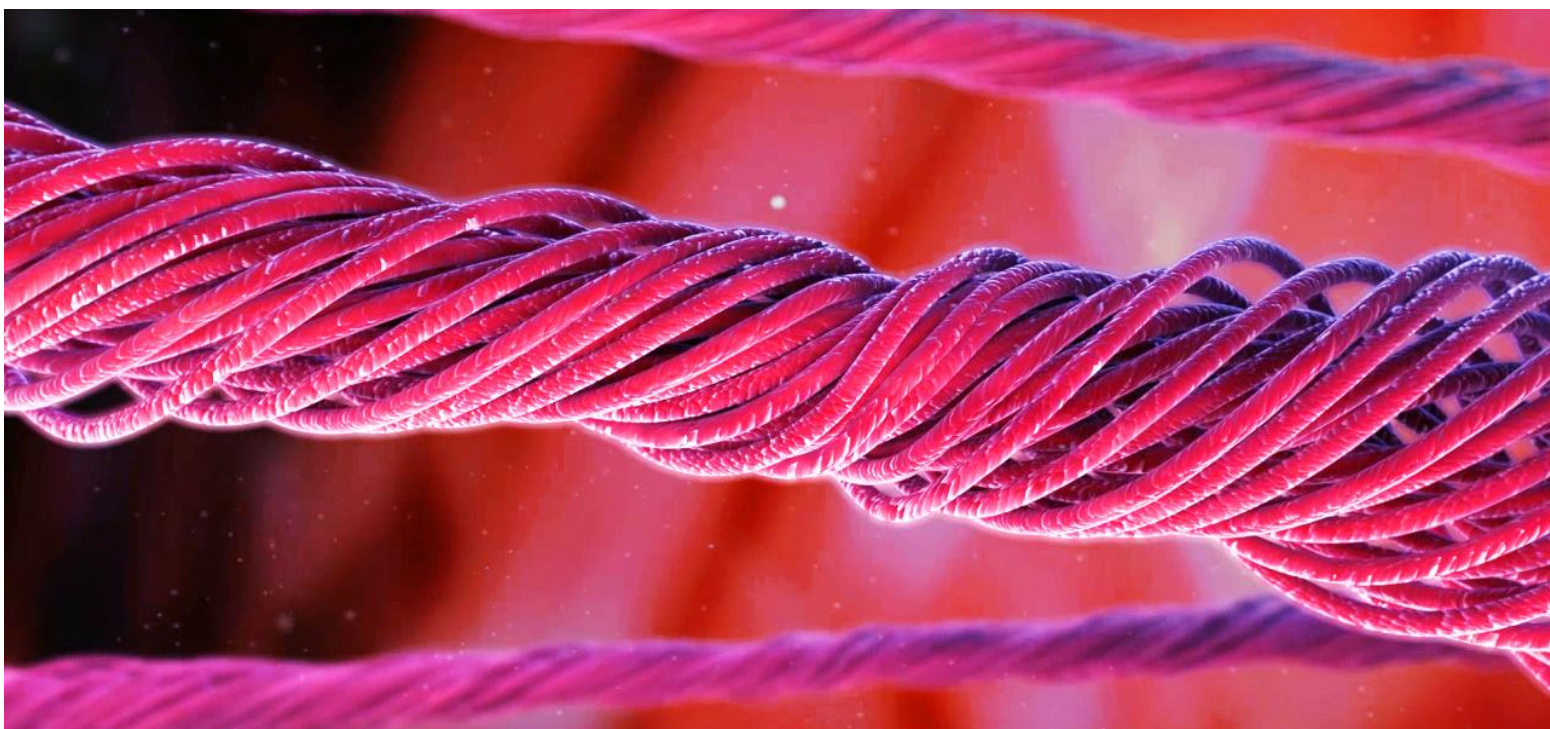
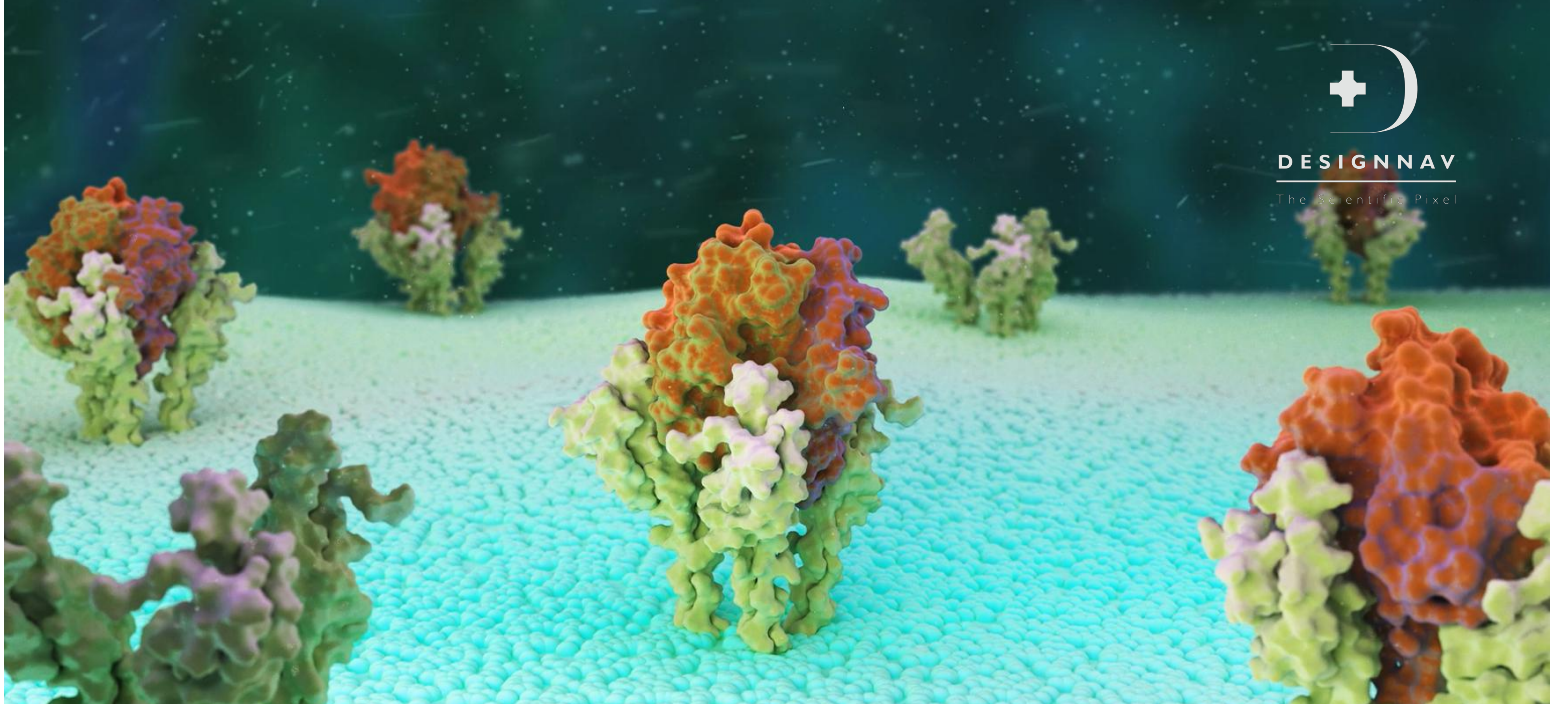

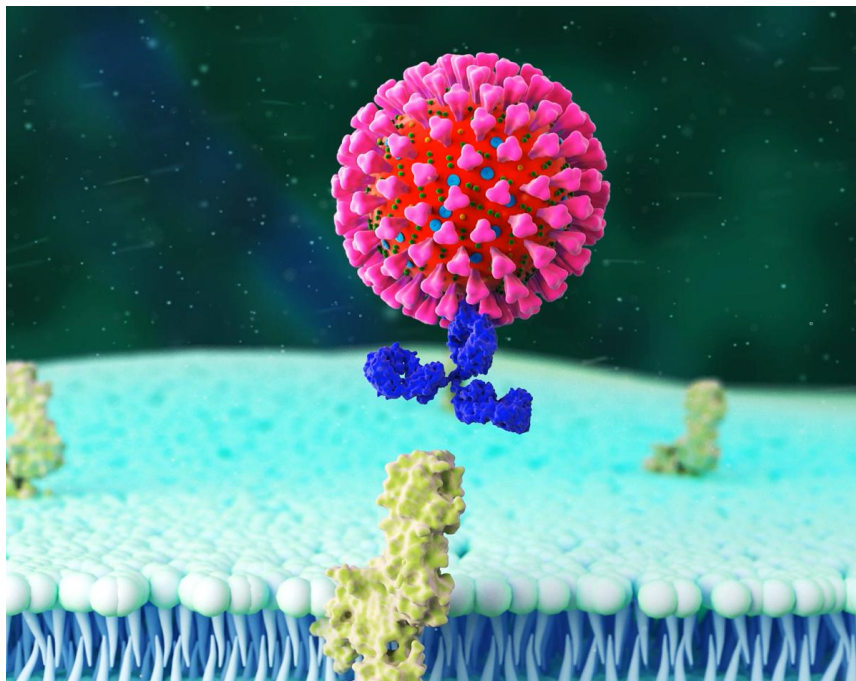
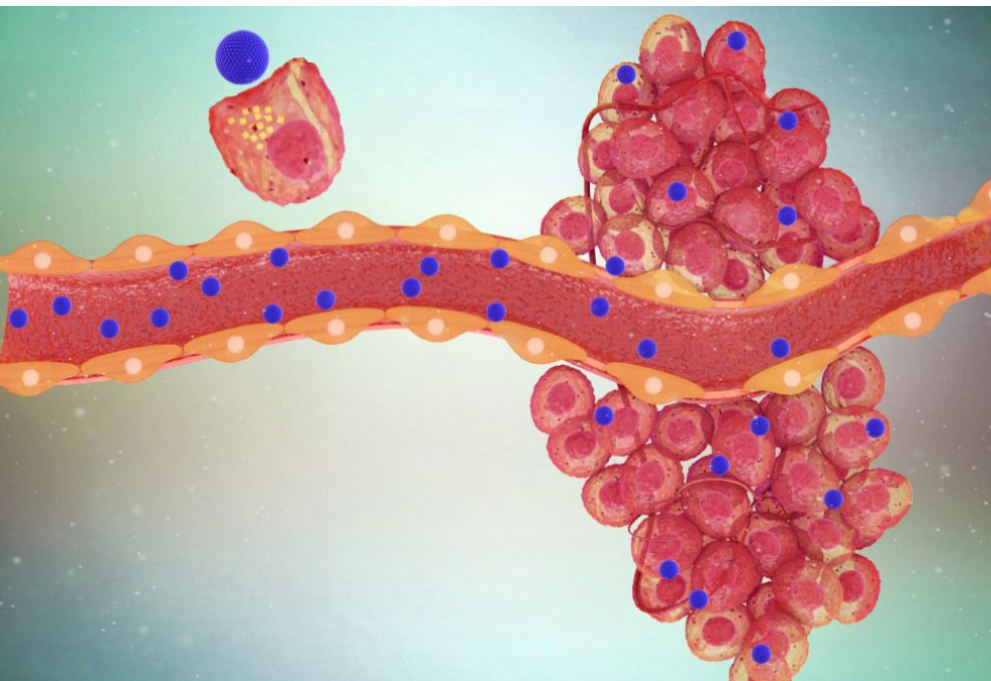
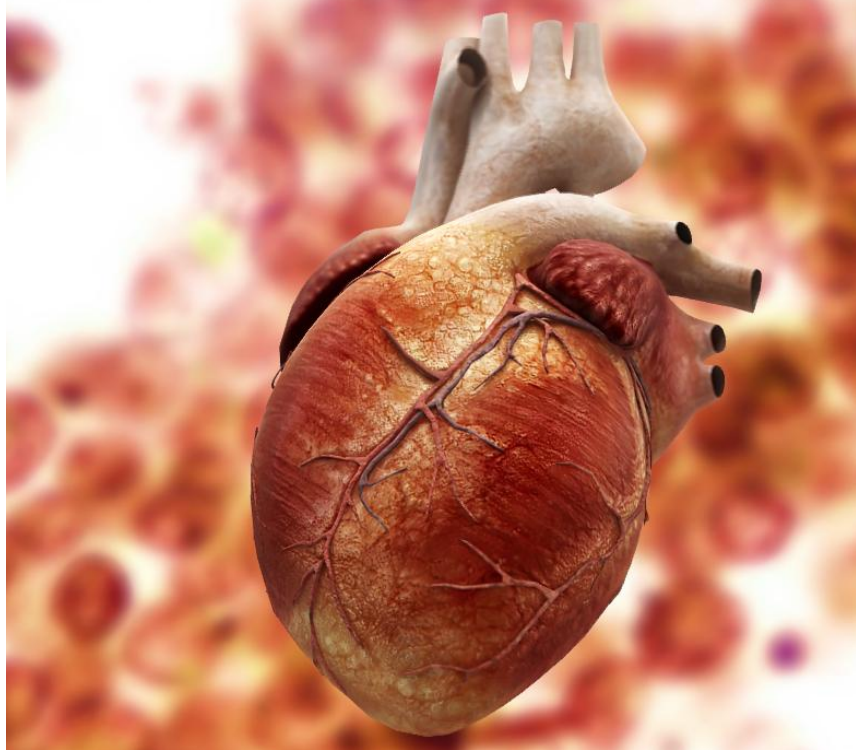
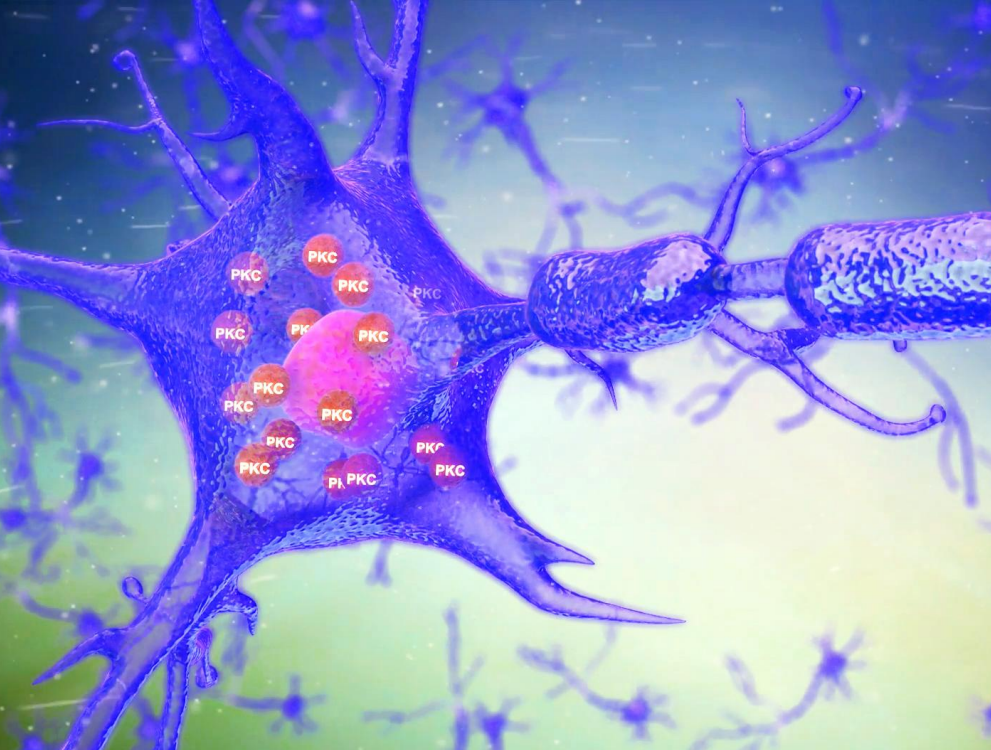

DESIGNNAV

The Scientific Pixel



DESIGNNAV
The Scientific Pixel

Scientific Animation Adds Value

Patient Education

Simplifies complex surgical concepts to build understanding, trust, and confidence.

Sales & Marketing

Enables sales teams to clearly communicate product benefits and procedures to doctors and distributors.

Surgeon Training

Helps surgeons understand implant design, placement, and surgical workflow with visual clarity.



DESIGNNAV
The Scientific Pixel

Medical Devices

We highlight medical devices, surgical tools, and healthcare equipment through precise and engaging animations designed for marketing, training, and product demonstrations.

Our team also supports product design development, including CAD modeling and detailed 3D renderings that accurately represent form, function, and usability. From concept visualization to realistic animation, we help manufacturers present their innovations with clarity, confidence, and technical precision.



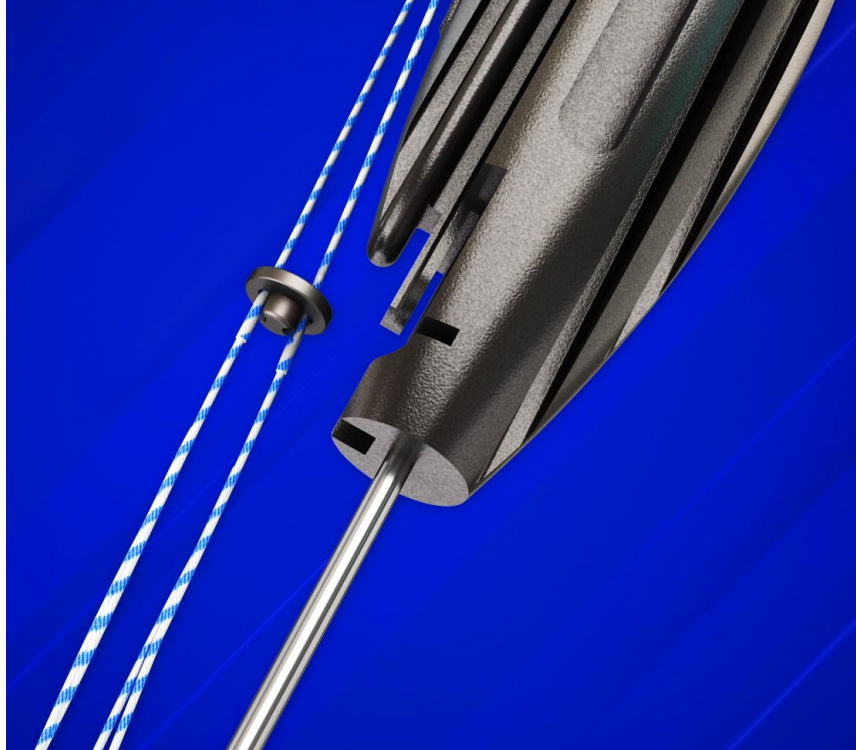

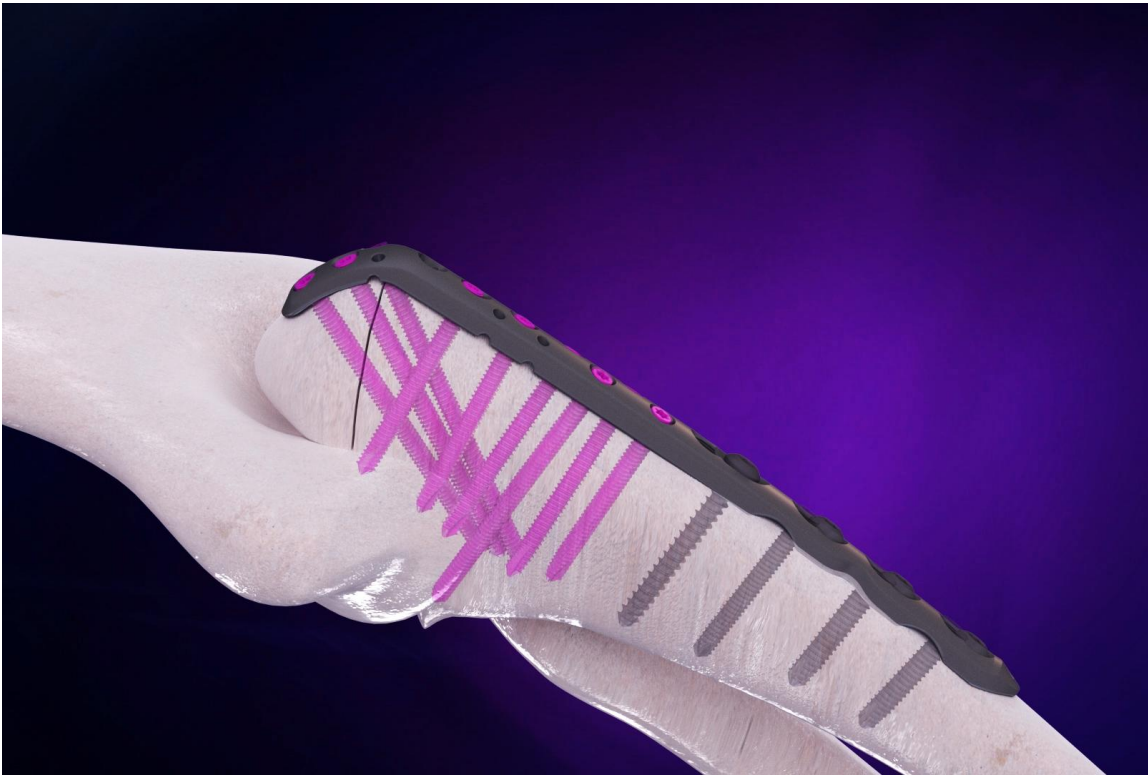

Implant Animation

Our orthopedic implant animations clearly showcase implant design, surgical techniques, and clinical benefits with high anatomical accuracy. Designed for training and marketing, they simplify complex procedures while maintaining scientific precision.

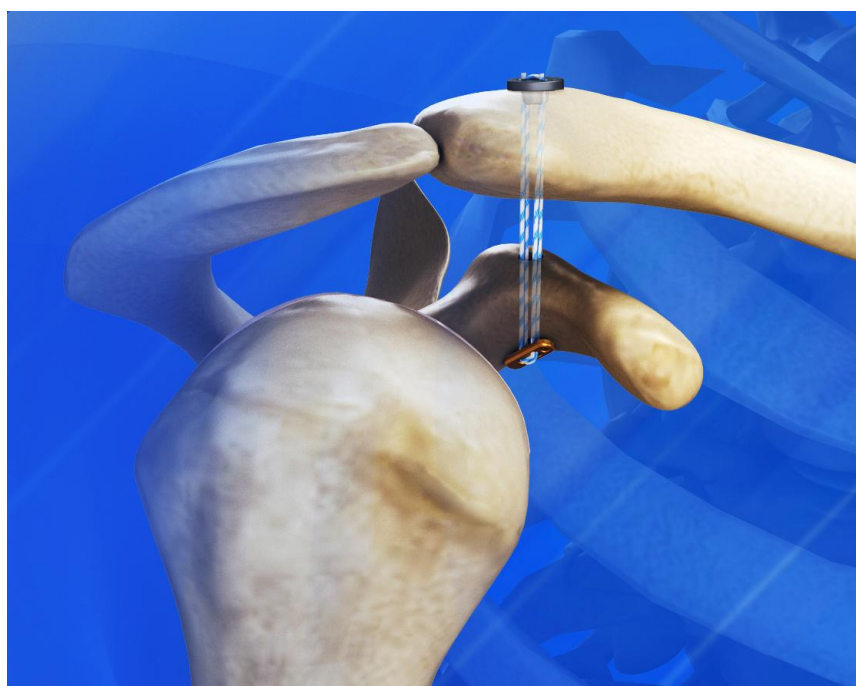
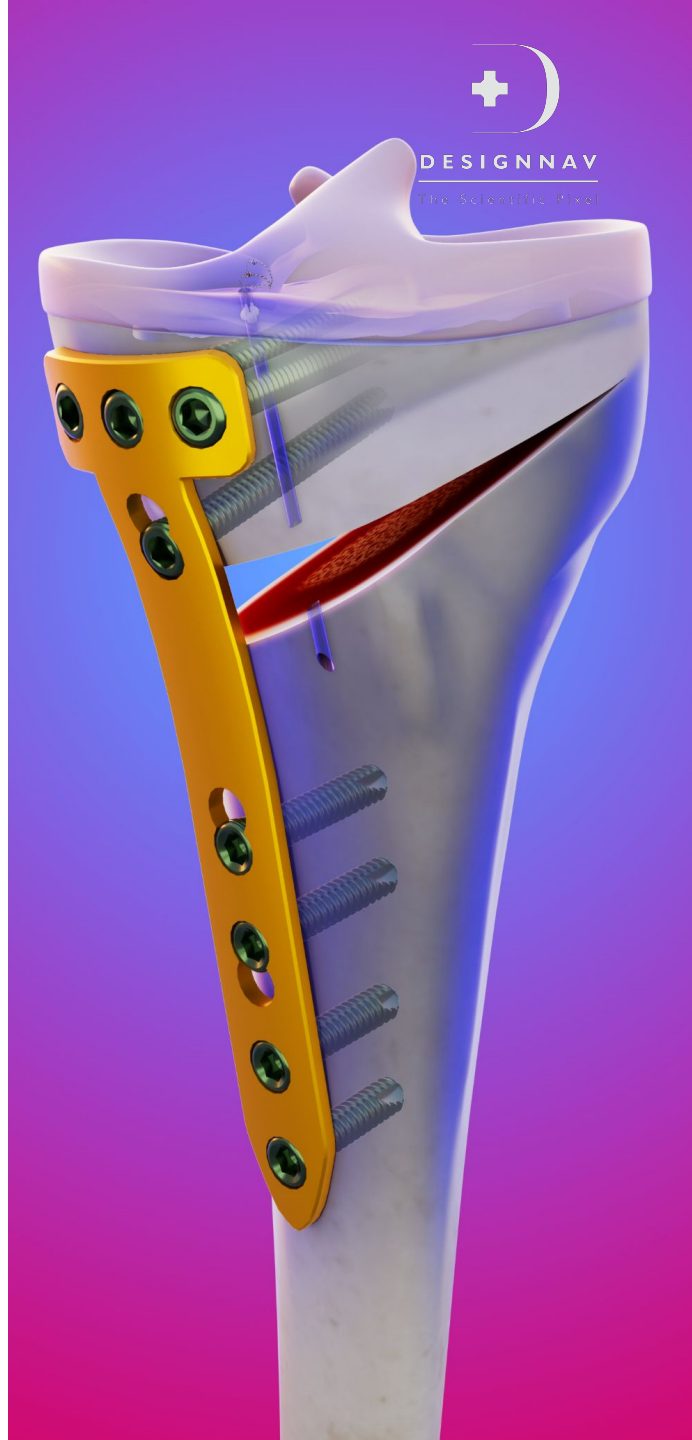
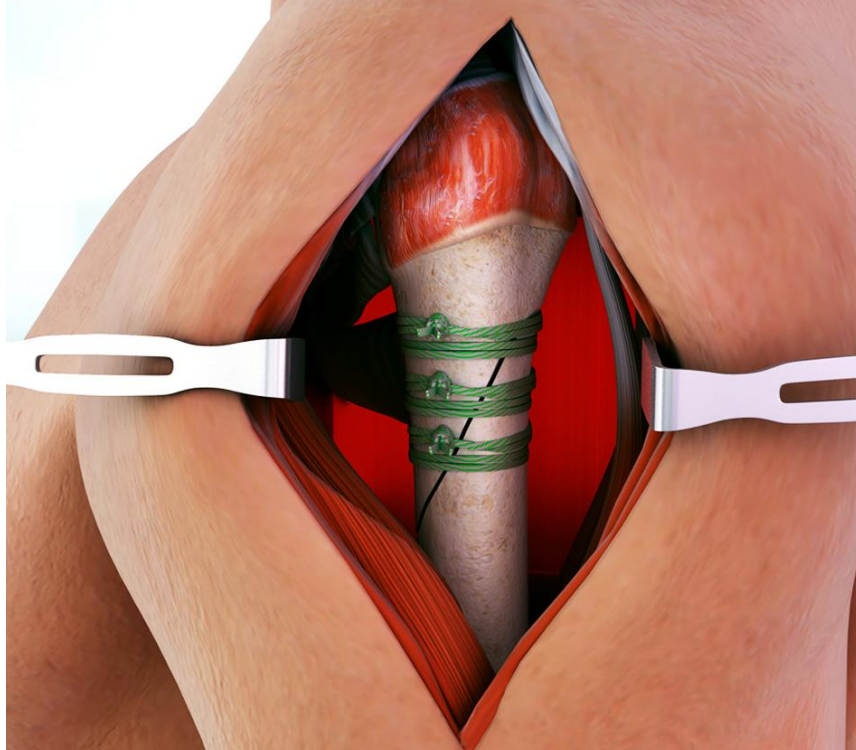



DESIGNNAV
The Scientific Pixel

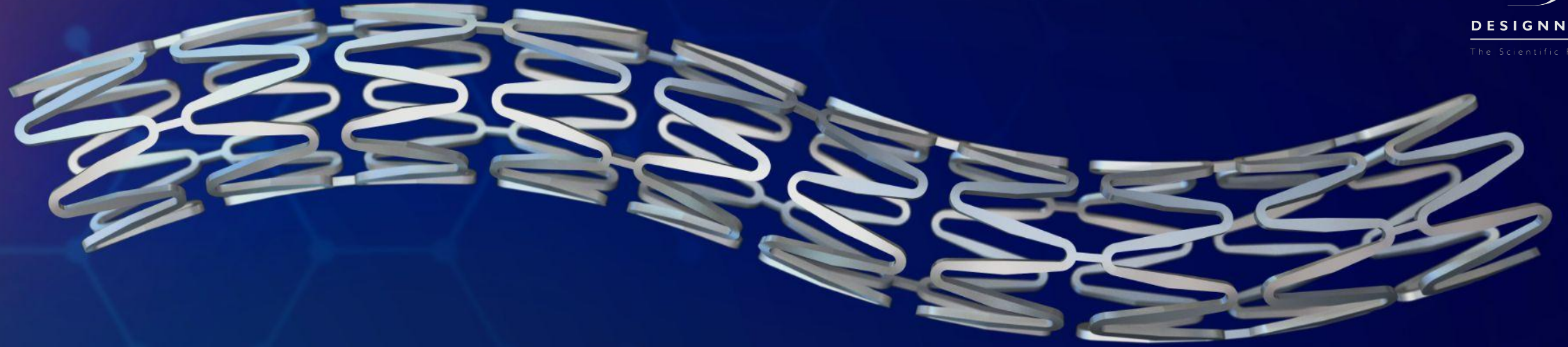

Turning Innovation into Impactful Visuals

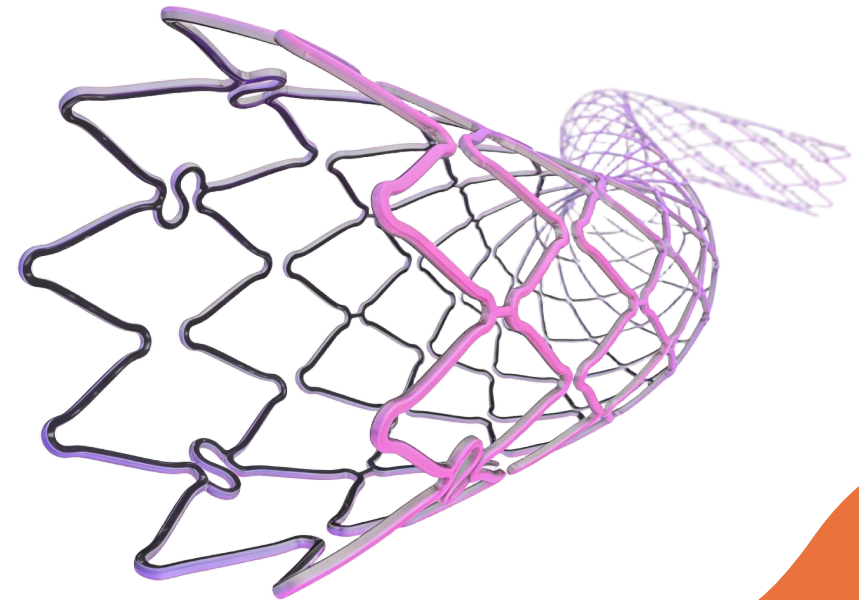
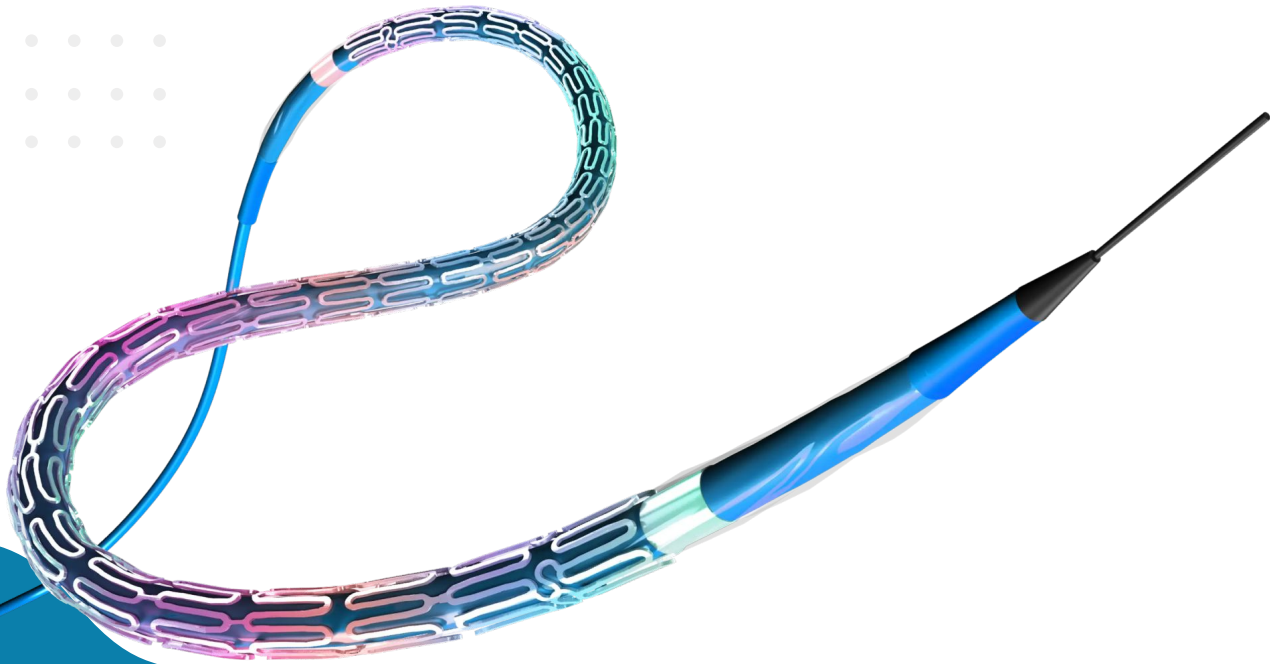



DESIGNNAV

The Scientific Pixel

Surgical Process Animation

Our surgical process animations visually demonstrate each step of a procedure with precision and anatomical accuracy. Designed to enhance understanding, they help surgeons, medical teams, and stakeholders clearly visualize workflows, techniques, and critical surgical stages for training, education, and communication.

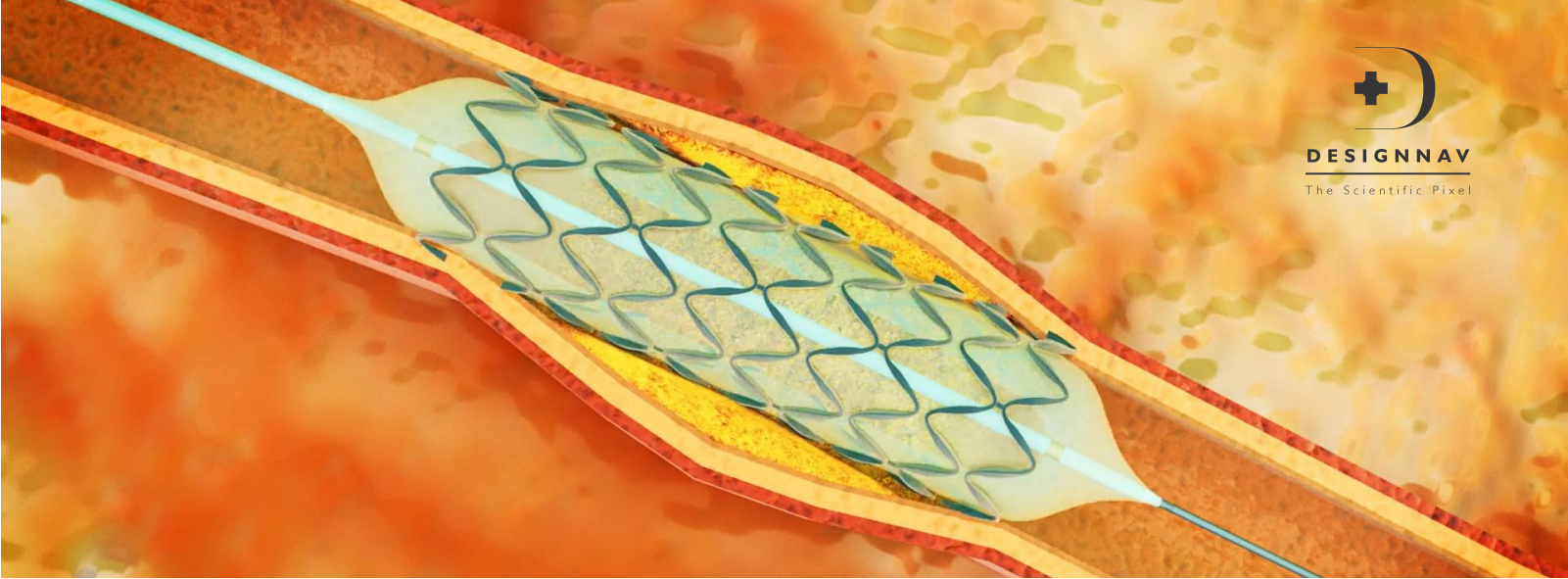

DESIGNNAV
The Scientific Pixel

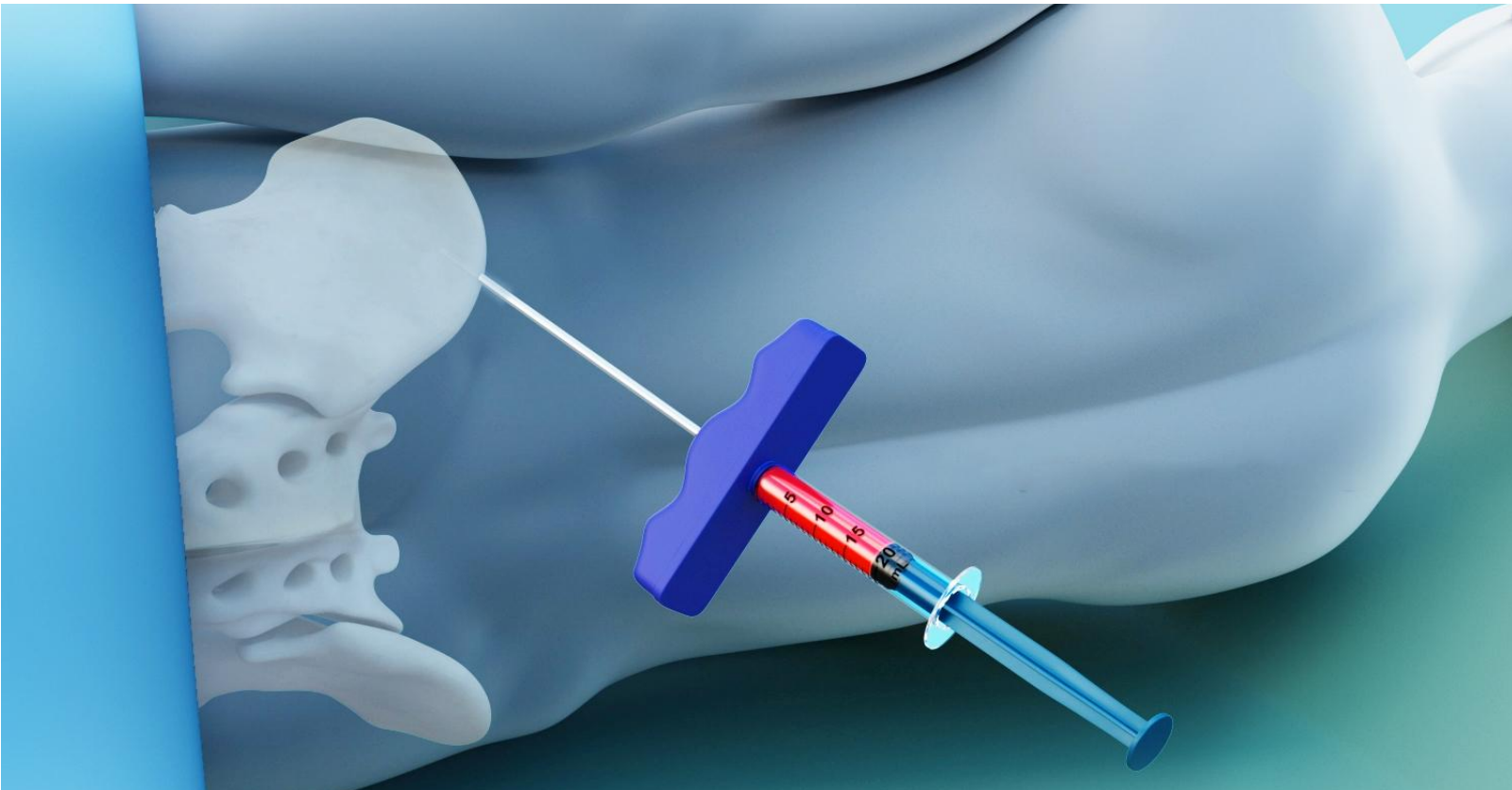

Explore the Power of Medical Storytelling



Step-by-Step Surgical Workflow

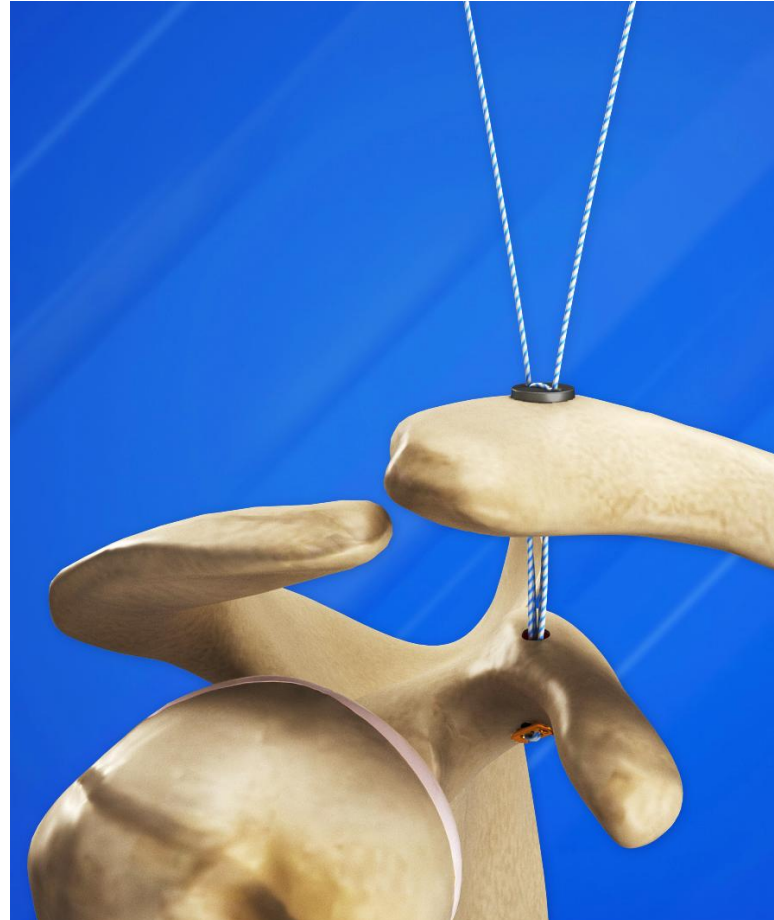

Controlled Implant Placement

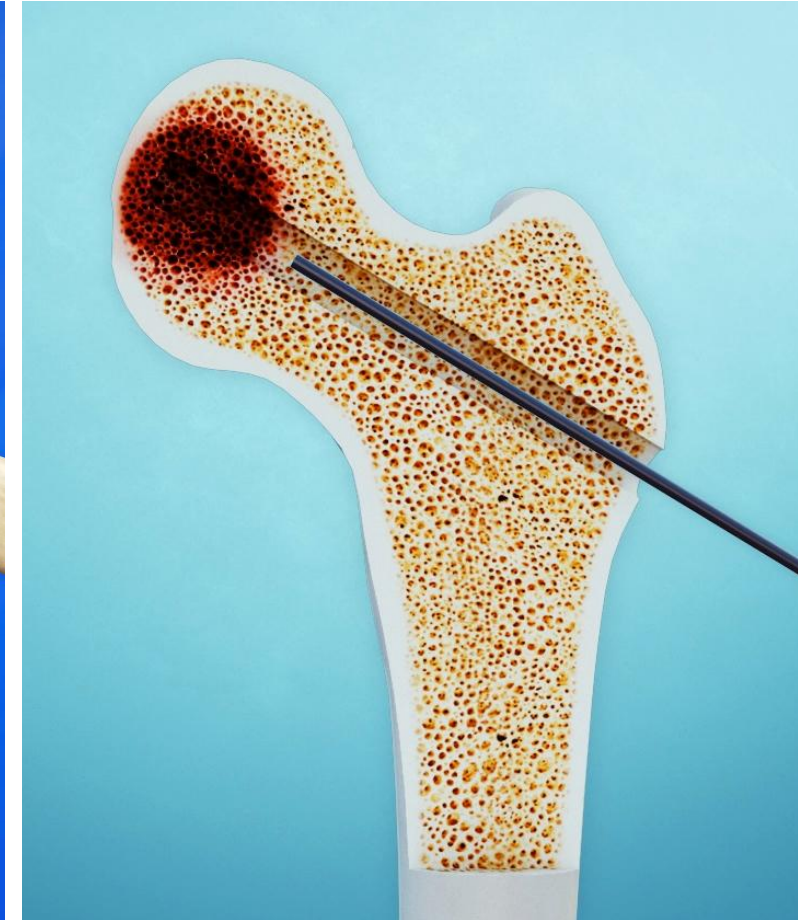

Clarity in Every Step



DESIGNNAV
The Scientific Pixel

Research and Ideation

Shaping physical products for production, focusing on form, usability, and human interaction.

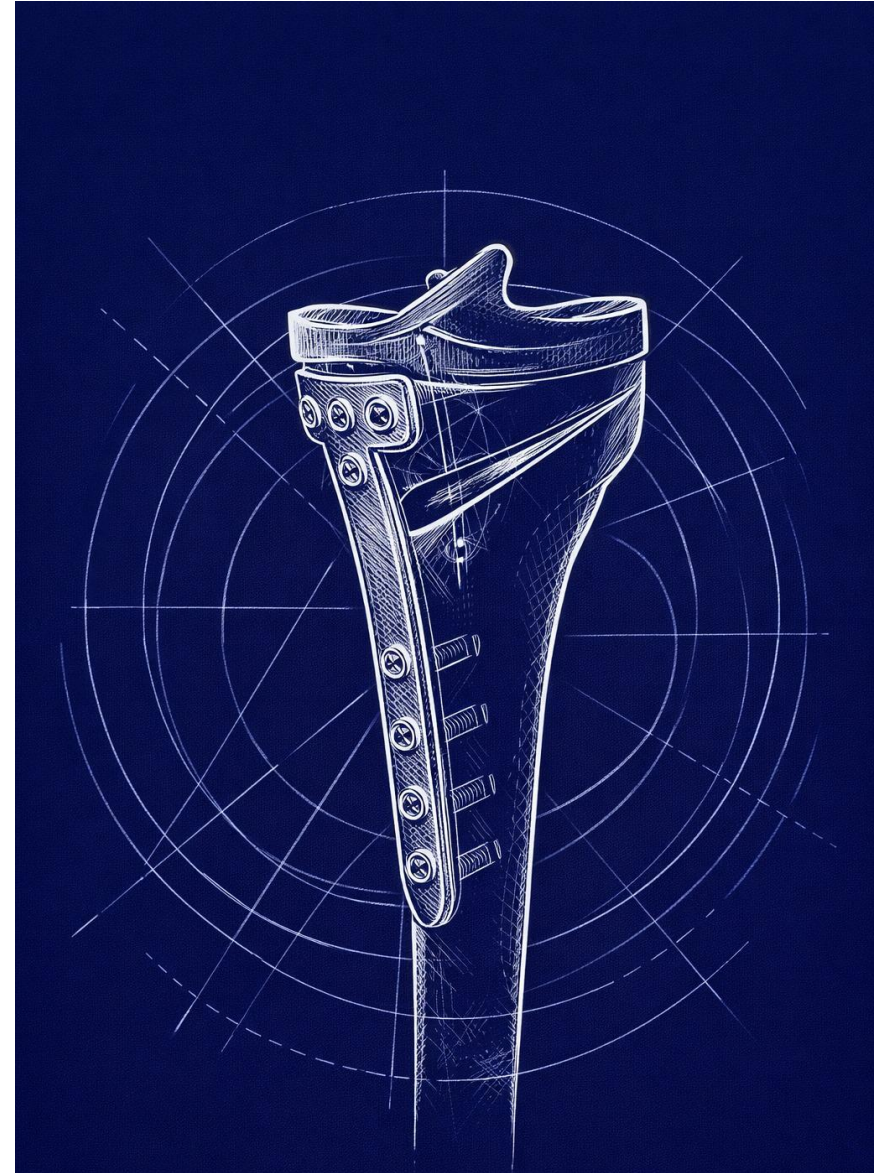
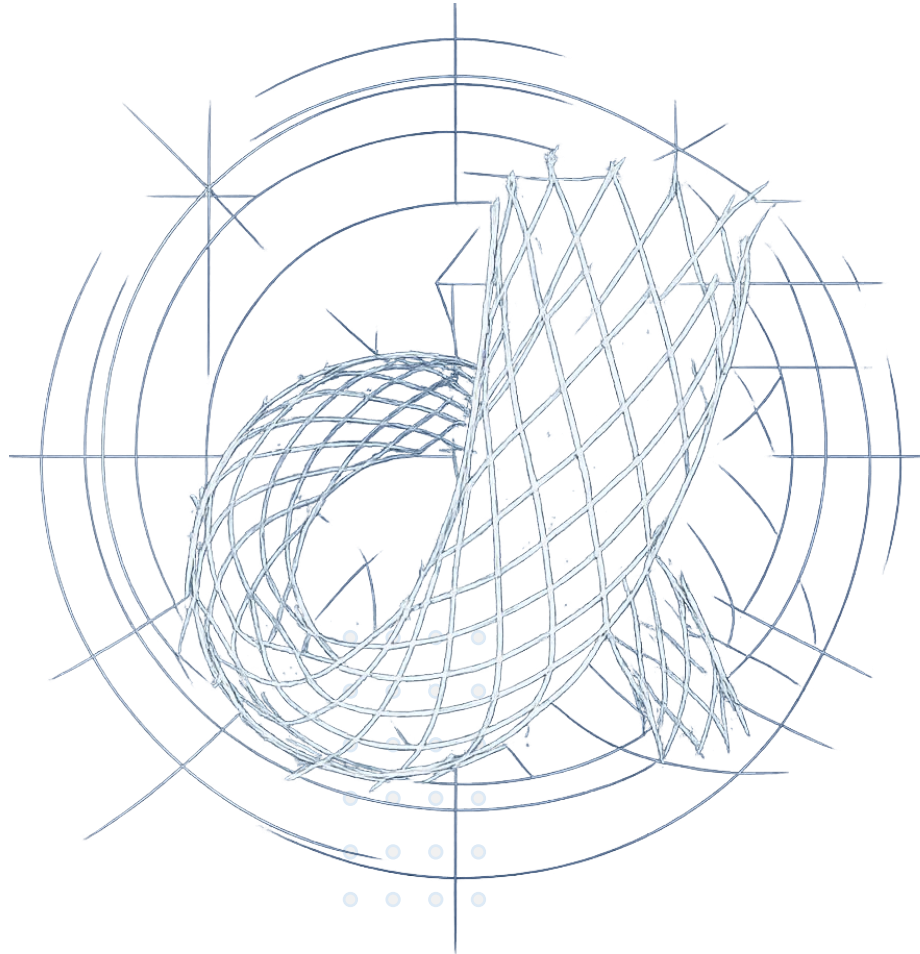



3d CAD Development

Advanced CAD solutions for medical and surgical products, ensuring design precision, functional integrity, and seamless transition from concept to production.



Product Outline Rendering

High-precision outline visuals that simplify complex product designs. These visuals are widely used in brochures, presentations, regulatory documents, patent filings, and marketing materials to communicate product clarity and functionality.

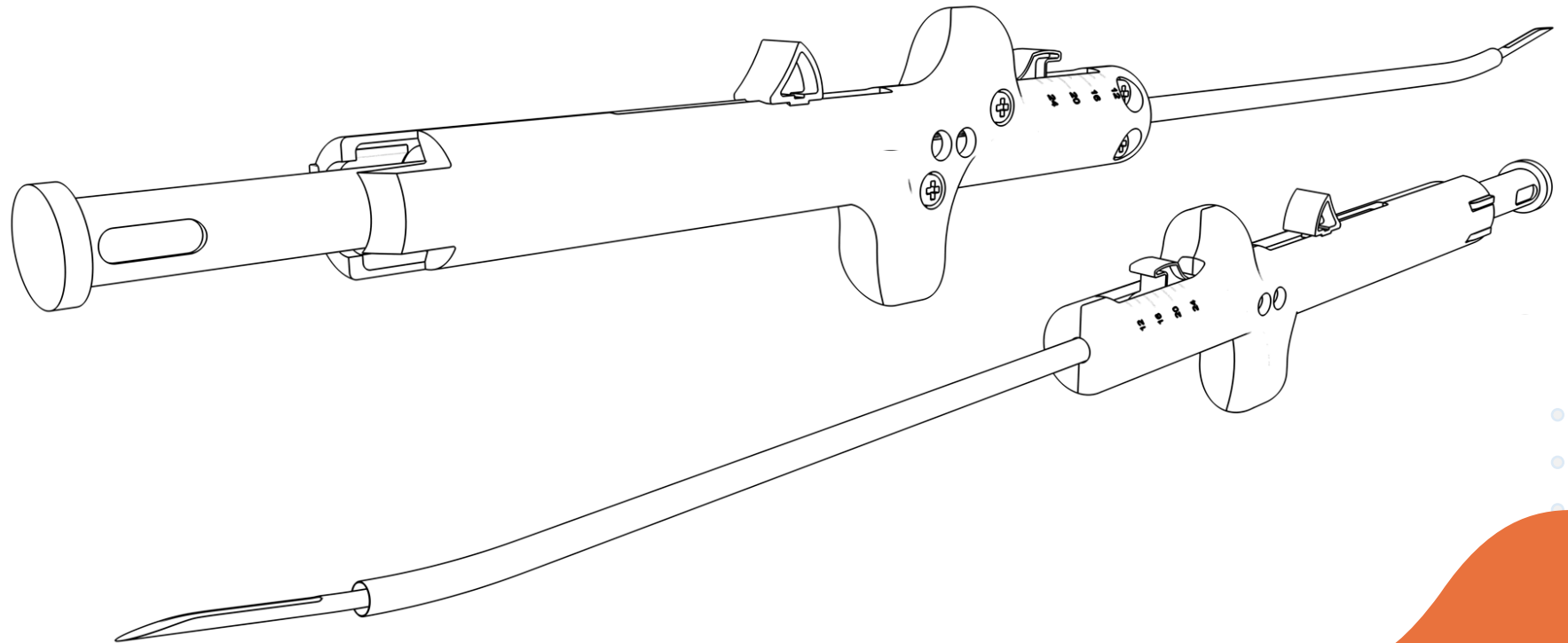

Simplifying Healthcare for Patients

At DESIGNNAV, we simplify complex medical information through clear and engaging patient education animations. Our visuals help patients understand their conditions, treatments, and procedures, enabling informed decisions while supporting healthcare providers in building trust and improving communication.

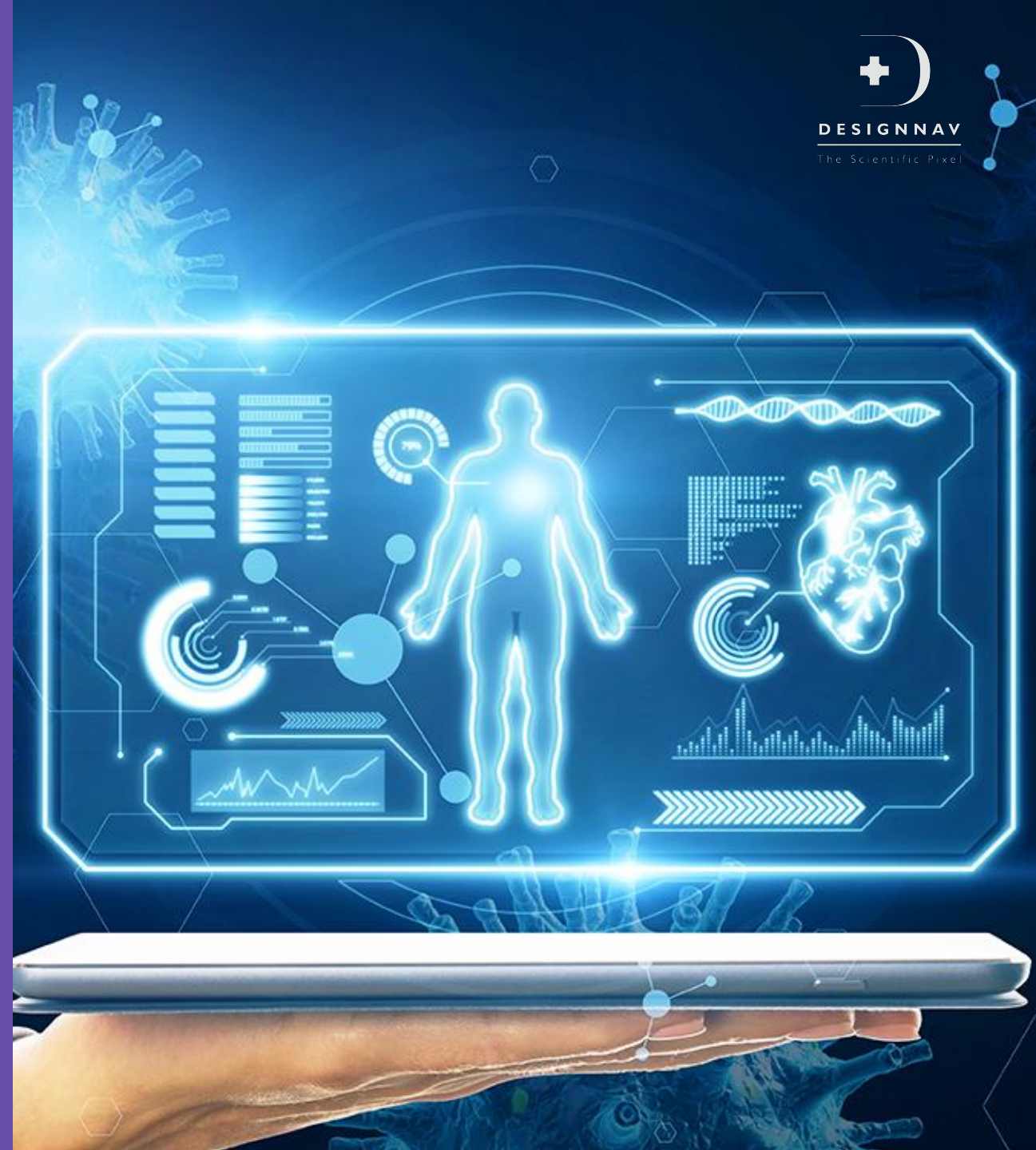

Patient Education Through Animation

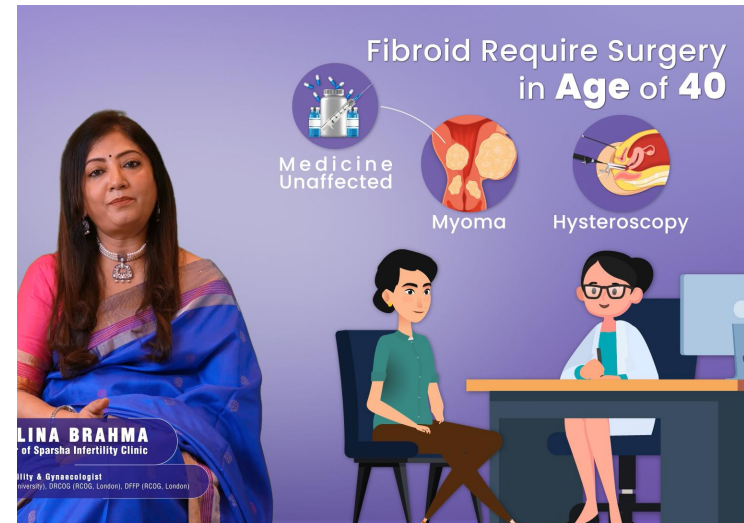
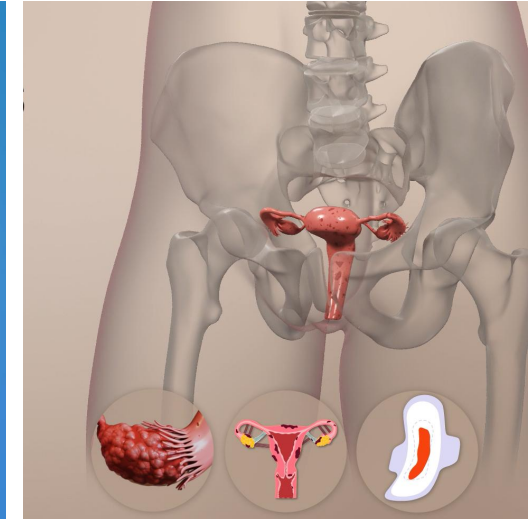
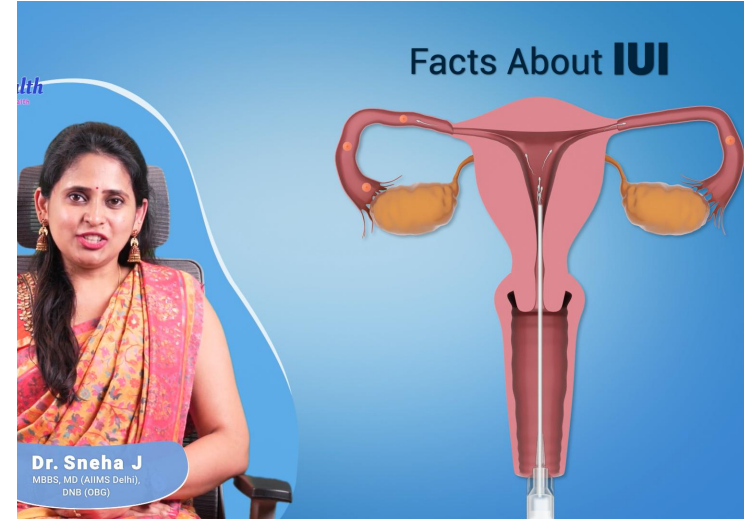
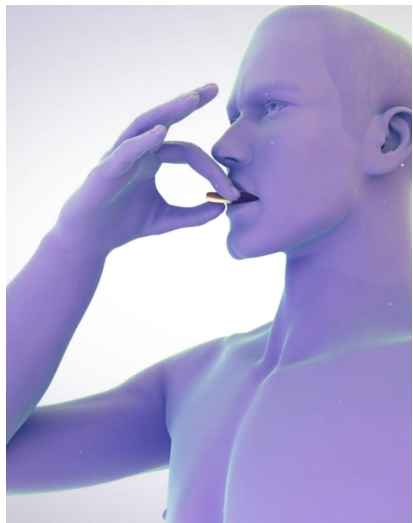



**DENTAL
SENSE PLUS**



DENTAL Education Platform

DENTAL SENSE PLUS, designed for dentists, dental manufacturers, and healthcare providers, our subscription-based platform also serves as a valuable tool for educating patients, enhancing trust, and improving communication in clinical settings.

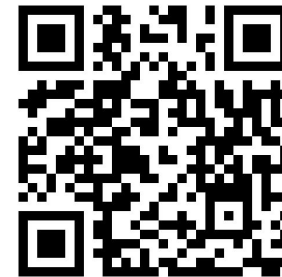



Dental
Patient
Education

DENTAL
SENSE PLUS



Laser Crown Lengthening

www.dentalsenseplus.com



Dental
Patient
Education

DENTAL
SENSE PLUS

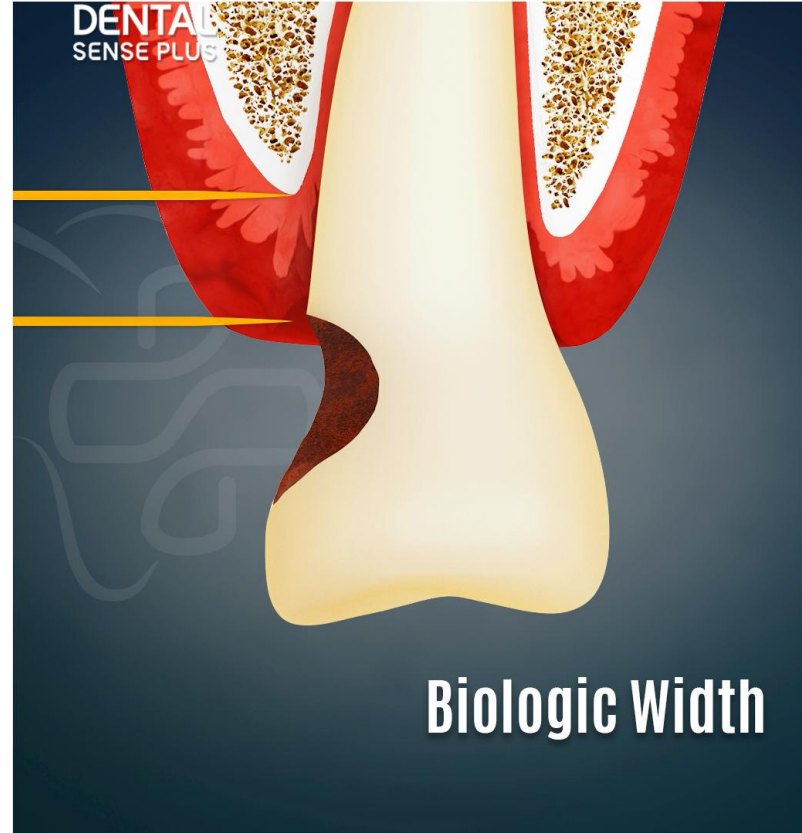

Biologic Width

www.dentalsenseplus.com

Educated Patient Have Better Outcomes

Dental Sense Plus presents a curated dental video library to help patients better understand procedures through clear, engaging visuals. Ideal for use in clinics, chairside, or waiting areas, these videos support patient education, reduce anxiety, and boost case acceptance - making dental communication more effective and professional.

Educate Patients Clearly
Build Patient Trust
Enhance Case Acceptance



Contact us

GET IN TOUCH WITH US



Ahmedabad, INDIA



info@designnav.com



(+91) 99247 33055



www.designnav.com

Thank You



DESIGNNAV

The Scientific Pixel

